



Multicolor Scan Laser Photocoagulator **MC-500 Vixi**
Multicolor Laser Photocoagulator **MC-500**



THE ART OF EYE CARE



MC-500 *Vixi* / MC-500

The Versatile Laser Photocoagulator

Selectable configuration of laser colors and delivery units

Multiple scan patterns

Enhanced usability

LPM (Low Power Mode)

The MC-500 Vixi / MC-500 provides a variety of laser treatments including panretinal photocoagulation for diabetic retinopathy and laser iridotomy for glaucoma with a scan slit lamp delivery unit. Additionally, our new LPM software allows easier setup for minimally invasive photocoagulation with a grid scan pattern.



Multicolor on Modular Architecture

Multicolor Laser for Multiple Applications

The MC-500 Vixi / MC-500 enables efficient photocoagulation even through opaque media. In cases of cataract, better penetration is achieved with the yellow (577 nm) laser compared to the green (532 nm) laser. In eyes with retinal hemorrhage, better penetration is achieved with the red (647 nm) laser.

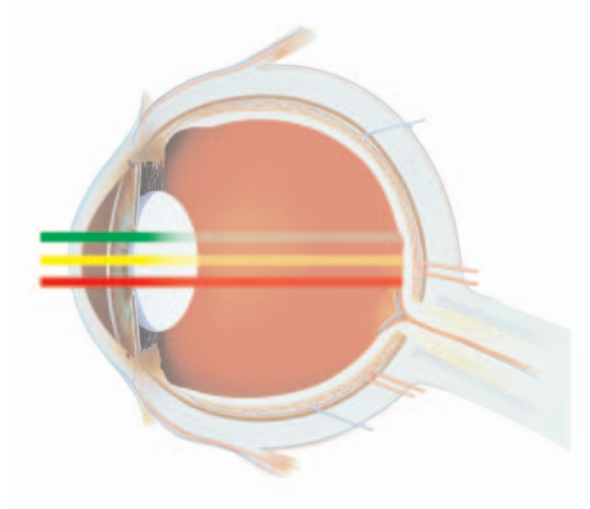

532 nm

The 532 nm (green) is the most common wavelength for treating retinal pathology.

577 nm

The 577 nm (yellow) laser is minimally absorbed by xanthophyll and is well absorbed by oxygenated hemoglobin compared to 561 nm and 568 nm lasers making it the wavelength of choice for lesions close to the macula. This wavelength has plentiful results achieved with the dye lasers.

647 nm

The 647 nm (red) wavelength has been historically used in krypton lasers. This wavelength is used for photocoagulation of deep choroidal pathology.

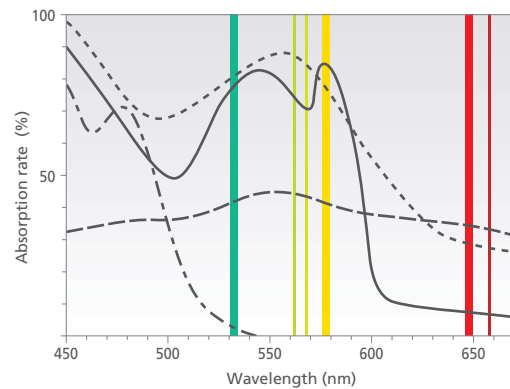

Reference: Folia Ophthalmol. Jpn. 40(5)1128-1133, 1989

- Pigment epithelium
- Reduced hemoglobin
- Oxygenated hemoglobin
- Xanthophyll
- 532 nm (MC-500, 300)
- 561 nm (MC-300)
- 568 nm (MC-7000)
- 577 nm (MC-500)
- 647 nm (MC-500, 7000)
- 659 nm (MC-300)

Selectable Laser Color Configuration

The MC-500 Vixi / MC-500, with its user friendly design, allows the selection of one, two, or three wavelengths, among green, yellow, and red. It enables the freedom to select the necessary color or combination of colors to increase efficiency of treatment.

Three-color selection	● ● ●		
Two-color selection	● ●	● ●	● ●
One-color selection	●	●	●

● Green ● Yellow ● Red

Multiple Scan Patterns

The MC-500 Vixi has 22 preprogrammed scan patterns to allow treatment of varying retinal pathologies.

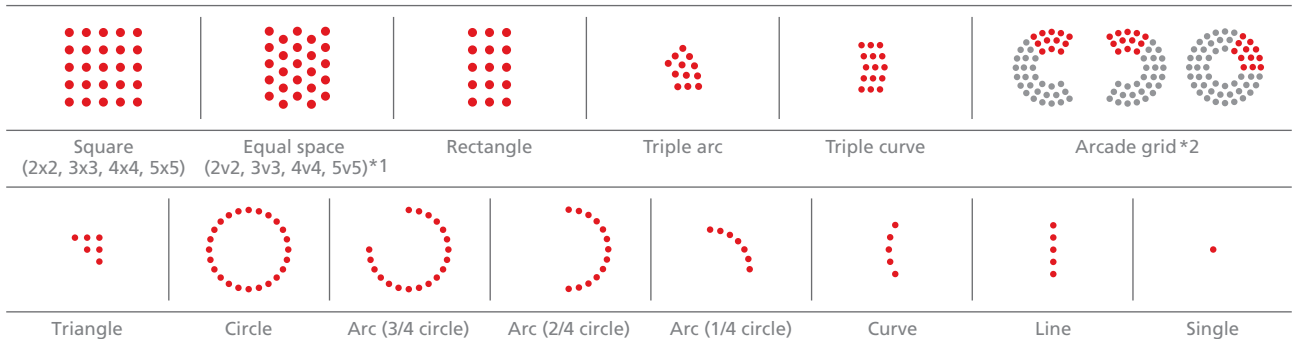

*1 For equal space patterns, No. v No. indicates the number of spots in horizontal and vertical directions.

*2 The arcade grid pattern is used for treatment of the periphery of macula in one-sixth units. The inner diameter is fixed and spot sizes range from 100 to 200 µm.

Typical Scan Patterns

Equal space (2v2, 3v3, 4v4, 5v5)

The space between spots is equal in all directions.



Square (2x2, 3x3, 4x4, 5x5)

The space between spots is equal in the horizontal and vertical directions.



The square pattern makes larger spaces in the diagonal direction than the horizontal and vertical directions. The equal space pattern keeps the spaces between spots equal allowing for denser photocoagulation than the square pattern.



Auto Forward*

Once photocoagulation is completed in one region, the MC-500 Vixi allows automated positioning of the scan pattern to the next region to undergo photocoagulation. This feature allows the surgeon to concentrate on focus adjustment.

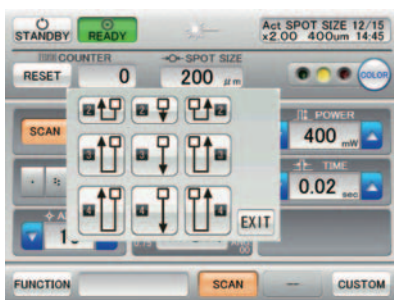

Selected path -

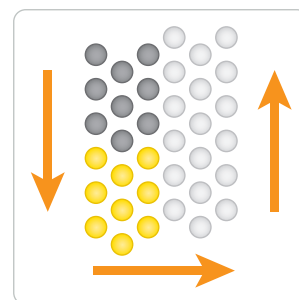

The repeat mode with the auto forward function enables consecutive regions to undergo photocoagulation on a selected path without repeatedly pressing the foot switch.

*The auto forward function is available for the equal space (2v2, 3v3, 4v4) and the square (2x2, 3x3, 4x4) patterns. The number of times of the forwarding differs depending on the scan pattern, spot size, and spacing.

Delivery Unit Options

Scan Delivery Units



Scan slit lamp delivery unit (NIDEK SL-2000)



Scan slit lamp delivery unit (NIDEK SL-1800)



Scan attachable delivery unit (NIDEK SL-2000/SL-1800/SL-1600)



Scan attachable delivery unit (ZEISS SL 130)



Scan attachable delivery unit (HAAG 900BQ / 900BQ LED slit lamp)

Single Delivery Units



Slit lamp delivery unit (NIDEK SL-1800)



Attachable delivery unit (NIDEK SL-1800/SL-1600)



Attachable delivery unit (ZEISS SL 130)



BIO delivery unit (HEINE OMEGA 500)



YAG laser combination delivery unit (NIDEK YC-1800)



Endophotocoagulation delivery unit (ZEISS, LEICA)

SOLIC (Safety Optics with Low Impact on Cornea)

All scan slit lamp and slit lamp delivery units including attachable models incorporate the SOLIC optical design that ensures low energy density on the cornea and lens even for large spot sizes.

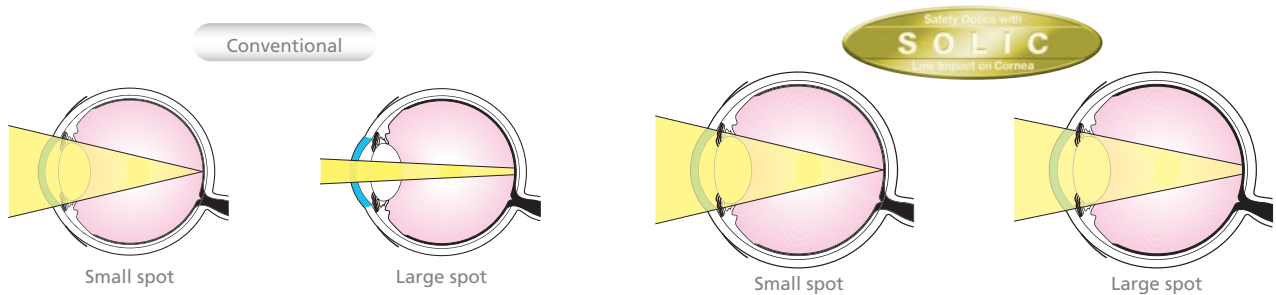

Continuously Variable Spot Size

The scan spot size is continuously variable from 100 to 500 μm (50 to 500 μm in single mode). The continuous variability enables the surgeon to easily compensate for the spot size change due to the use of a laser contact lens.

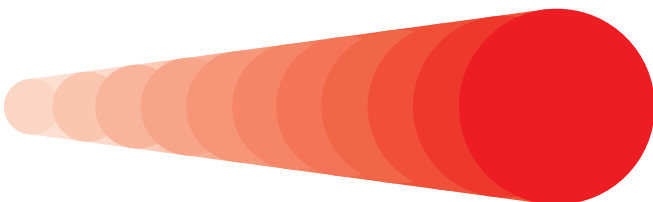

Stable Laser Power Output

Momentary increase followed by a plateau and an immediate decrease enables rapid and high-power laser emission on the scan patterns.

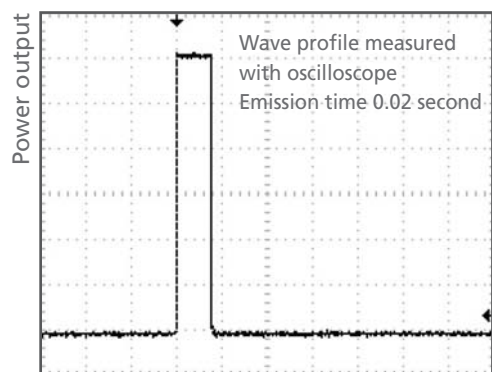

Time

Practical and User-friendly Features

Intuitive graphic user interface and easy-to-read color LCD touch screen allows easy and quick setup and confirmation of the scan pattern and treatment parameters.

Pop-up Window

The pop-up window appears once the displayed value, such as POWER, TIME or ITVL, is touched. It enables the surgeon to make significant changes to the laser values quickly with two-touch operations.

1. Touch the value on the screen
2. Select the value on the pop-up window

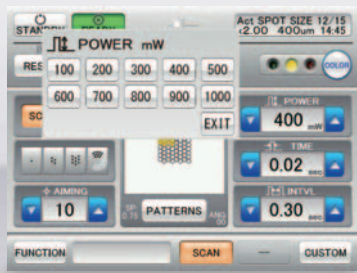

Spot Size

The spot size of the scan slit lamp delivery unit and slit lamp delivery unit is displayed on the LCD, and can be read with other parameters even in a dark room.

Actual Spot Size

The converted spot size is displayed once the laser spot magnification of laser contact lens is selected on the pop-up window.



MC-500 Vixi LCD screen

This screen displays all buttons and items for convenience sake, but the actual screen is not consistent with this sample screen.

Memory of Scan Pattern

Four frequently used scan patterns can be saved and recalled with one-touch selection.

Memory of Photocoagulation Data

In accordance with various clinical cases, up to 10 sets of photocoagulation data (color, power output, emission time, interval time, scan pattern, and spacing) can be registered. Each set is retrievable quickly with one-touch operation.

Memory No	Name	Color	Power mW	Time sec	Intvl sec	Ptn	SP
1	PRP Scan G	G	300	0.020	0.00	3x3	0.75
2	PRP Scan Y	Y	300	0.020	0.00	3v3	0.75
3	PRP G	G	200	0.200	0.40		
4	PRP Y	Y	150	0.200	0.40		
5	BRVO	G	200	0.200	0.00		
6	CRVO	R	200	0.200	0.00		
7	LI-1	G	200	0.200	0.00		
8	LI-2	G	1000	0.020	0.00		
9			000	0.000	0.00		
10			000	0.000	0.00		

LPM (Low Power Mode)

Minimally Invasive Photocoagulation

LPM (Low Power Mode) is a form of laser treatment that delivers reduced power to the retina. In LPM, the standard (yellow) laser treatment power is reduced by a specified ratio.

To use the optional LPM, the MC-500 Vixi has to be equipped with the yellow laser. An additional software upgrade is required.

Laser Treatment for Macular Edema

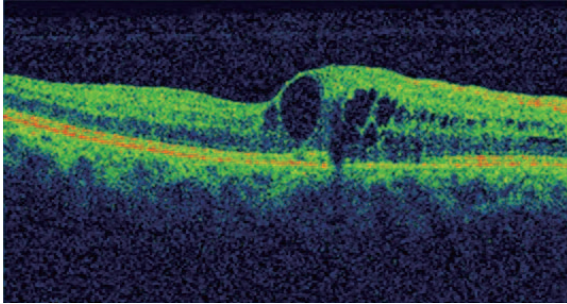

Before

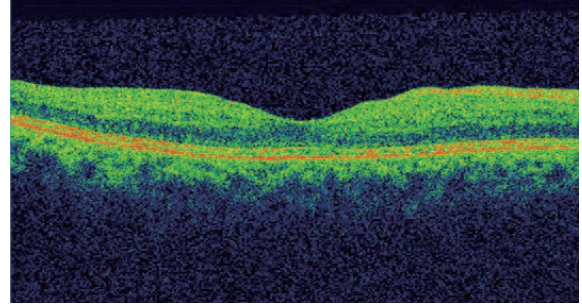

After treatment with LPM

Sample image – Outcomes may vary based on patient-specific response.

■ Advantage of LPM function

Arcade Grid Scan Pattern

In addition to regular mode, LPM includes a scan pattern that prevents treatment in a central circular area within the grid. Selecting the "Pos" (Position) button to align the aiming beam to the foveal center activates treatment that follows the grid scan pattern.

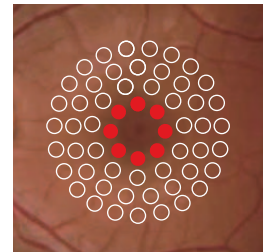
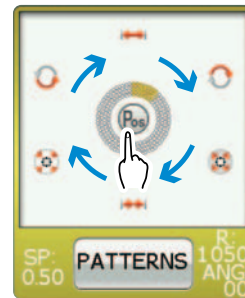

Auto Forward Function

The auto forward function is available for LPM. The MC-500 Vixi allows automated positioning of the scan pattern for photocoagulation.

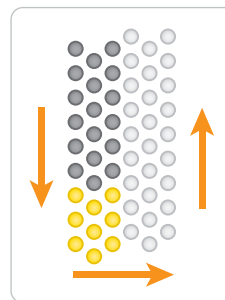

**More Clinical Information available online
at the NIDEK Education page**

For more clinical information, please visit the Education page on the NIDEK website. This site allows access to case reports, journal articles, and video presentations.



<https://www.nidek-intl.com/education/>



Videos



Case reports

Main Body Specifications

Laser type	Solid state laser, Diode laser
Wavelength	Green : 532 nm Yellow : 577 nm Red : 647 nm
Power output	Green: 50 to 1,700 mW*1 Yellow: 50 to 1,500 mW Red: 50 to 800 mW*2
Output type	Continuous wave
Emission time	0.01 to 1.00 s, 2.00 s, 3.00 s*3
Interval time	0.05 to 1.00 s*4
Aiming beam	Red diode, 670 nm, max. 0.6 mW
Cooling system	Air cooling
Power supply	115/230 V AC, 50/60 Hz
Power consumption	400 VA
Dimensions/Mass	300 (W) x 480 (D) x 670 (H) mm / 35 kg 11.8 (W) x 18.9 (D) x 26.4 (H)" / 77.1 lbs.
Optional accessories	3D mouse, Control box, Remote control

*1 50 to 1,500 mW with scan delivery unit

*2 With the slit lamp delivery unit, scan slit lamp delivery unit, attachable delivery unit, and scan attachable delivery unit, the maximum power output is limited according to the spot size.
Spot size 50 µm - 500 mW, Spot size 60 µm - 600 mW, Spot size 70 µm - 700 mW

*3 0.01 to 0.05 second in scan mode

*4 0.10 to 1.00 second in auto manipulation mode and auto forward function

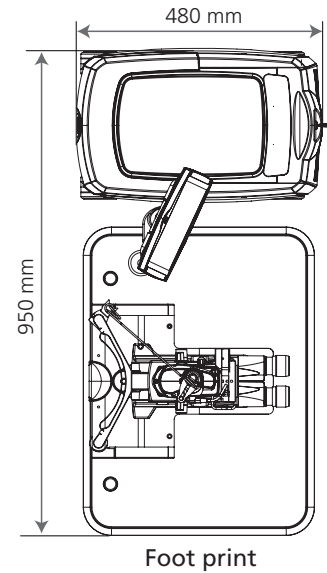

Scan / Single Delivery Unit Specifications

Model	Scan delivery unit (MC-500 Vixi)	Single delivery unit (MC-500)
Spot size	100 to 500 µm (scan mode & auto manipulation mode) 50 to 500 µm (single mode)	50 to 1,000 µm (slit lamp & attachable deliveries)
Emission pattern	Single Square (2x2, 3x3, 4x4, 5x5), Equal space (2v2, 3v3, 4v4, 5v5)*5, Rectangle, Triple arc, Triple curve, Arcade grid, Triangle, Circle, Arc (3/4 circle, 1/2 circle, 1/4 circle), Curve, Line	Single
Type	Scan slit lamp delivery unit (NIDEK SL-2000/SL-1800) Scan attachable delivery unit (NIDEK SL-2000/SL-1800/SL-1600, ZEISS SL 130, HAAG 900BQ / 900BQ LED slit lamp)	Slit lamp delivery unit (NIDEK SL-1800) Attachable delivery unit (NIDEK SL-1800/SL-1600, ZEISS SL 130) BIO delivery unit (HEINE OMEGA 500) YAG laser combination delivery unit (NIDEK YC-1800) Endopotocoagulation delivery unit (ZEISS, LEICA)
Dimensions/Mass	600 (W) x 450 (D) x 1,300 to 1,500 (H) mm / Approximately 45 kg*6 23.6 (W) x 17.7 (D) x 51.2 to 59.1 (H)" / Approximately 99.2 lbs.*6 (NIDEK SL-1800 scan slit lamp delivery with table)	← ← (NIDEK SL-1800 slit lamp delivery with table)

*5 For equal space patterns, No. v No. indicates the number of spots in horizontal and vertical directions.

*6 The dimensions and mass differ depending on delivery types.

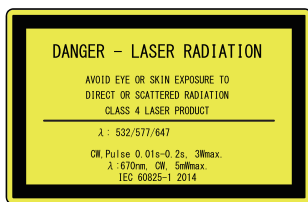

Product/Model name: Multicolor Laser Photocoagulator MC-500

Brochure and listed features of the device are intended for non-US practitioners.

Specifications may vary depending on circumstances in each country.

Specifications and design are subject to change without notice.

All brand and product names are trademarks or registered trademarks of their respective companies.



HEAD OFFICE
(International Div.)
34-14 Maehama,
Hiroishi-cho, Gamagori,
Aichi 443-0038, JAPAN
TEL: +81-533-67-8895
URL: www.nidek.com
[Manufacturer]

TOKYO OFFICE
(International Div.)
3F Sumitomo Fudosan Hongo
Bldg., 3-22-5 Hongo, Bunkyo-ku,
Tokyo 113-0033, JAPAN
TEL: +81-3-5844-2641
URL: www.nidek.com

NIDEK INC.
2040 Corporate Court,
San Jose, CA 95131, U.S.A.
TEL: +1-408-468-6400
+1-800-223-9044
(US Only)
URL: usa.nidek.com

NIDEK S.A.
Europarc,
13 rue Auguste Perret,
94042 Créteil, FRANCE
TEL: +33-1-49 80 97 97
URL: www.nidek.fr

NIDEK TECHNOLOGIES S.R.L.
Via dell'Artigianato,
6/A, 35020 Albignasego (Padova),
ITALY
TEL: +39 049 8629200/8626399
URL: www.nidektechnologies.it

NIDEK (SHANGHAI) CO., LTD.
Rm3205, Shanghai Multi
Media Park, No.1027 Chang
Ning Rd, Chang Ning District,
Shanghai, CHINA 200050
TEL: +86 021-5212-7942
URL: www.nidek-china.cn

NIDEK SINGAPORE PTE. LTD.
51 Changi Business Park
Central 2, #06-14,
The Signature 486066,
SINGAPORE
TEL: +65 6588 0389
URL: www.nidek.sg